

Centrifugal single stage pump for water stream

Applications

Generation of a strong water stream to transform swimming pools into a place for sport and leisure.
Self-priming up to 4m.

Materials

Pump body, impeller, diffuser, suction and discharge in technopolymer.
Pump shaft in AISI 431.
Mechanical seal.
Motor casing in aluminium.
O-rings in NBR.

Equipment

No cable.
Unions included.

Motor

Asynchronous 2 poles.
IP 55 protection.
Class F insulation.
Single phase motor with built-in thermal protection.
Continuous operation.

Limitations

Maximum water temperature: 40° C.



Hydraulic performance table

Model	I [A]			P1 [kW]		P2		c [μF]	l/min m³/h									Code	
	1~230V	3~230V	3~400V	1~	3~	[kW]	[HP]			100	200	400	600	800	1000	1200	1300	1~230V	3~230V/400V
Nadorself 200	10,2	7	4,1	2,2	2,2	1,5	2	40	12,9	12,2	10,6	8,5	6	-	-	-	203165	203167	
Nadorself 300	13,4	8,6	5	3	3	2,2	3	60	14,6	14	12,8	11,3	9	6,5	-	-	203166	203168	
Nadorself 400	-	11,8	6,8	-	3,4	3	4	-	17,2	16,6	15,3	13,8	11,6	9,4	6,3	4,5	-	203169	

Performance curve at 2900 rpm

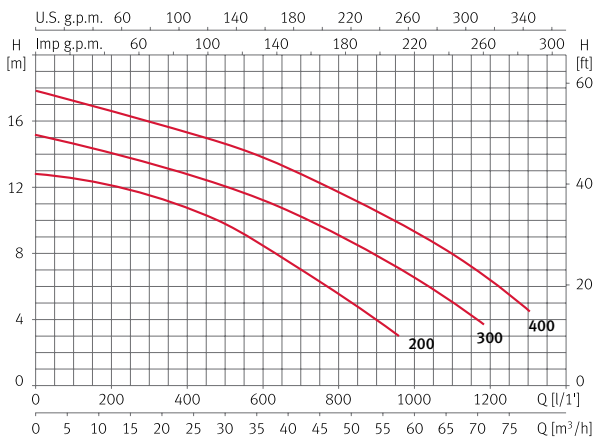

Dimension and weight

Model	A	B	C	D	E	F	G	H	I	Kg
Nadorself 200	416	335	615	130	249	419	70	2 1/2"	47	25,1/23,1
Nadorself 300	416	335	615	130	249	419	70	2 1/2"	47	26,1/25,8
Nadorself 400	416	335	615	130	249	419	70	2 1/2"	47	28

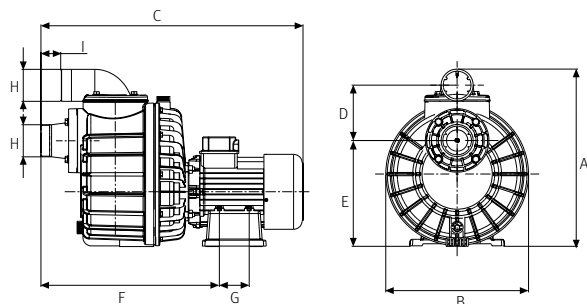

Wiper 3

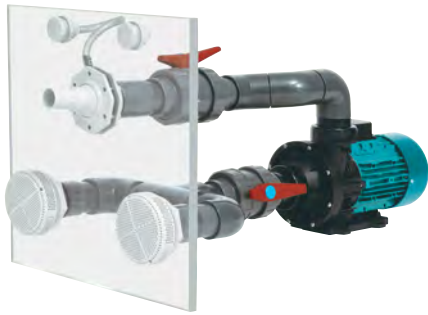

Suction kit	Code
Suction kit for liner pools	130634



Suction kit	Code
Suction kit for concrete pools	130633



Discharge kit	Code
Discharge kit for liner and concrete pools	130632



Hose kit	Code
Hose kit 1,5m	104153

Nadorsel

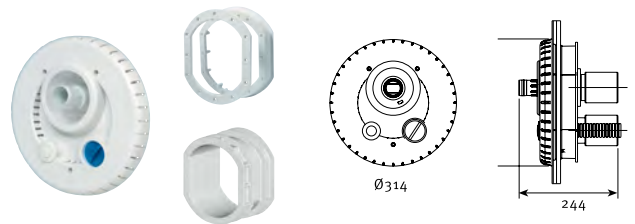
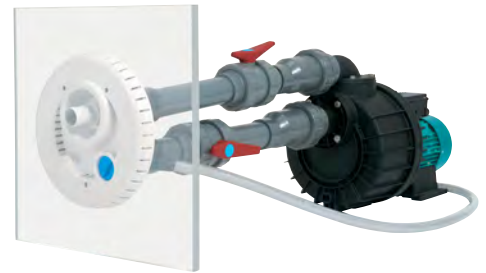

Circular kit	Code
Suction and discharge circular kit	128188
Bushing wall kit for liner and concrete pools	146558

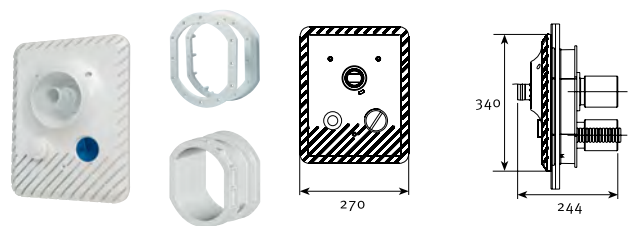

Rectangular kit	Code
Suction and discharge rectangular kit	128189
Bushing wall kit for liner and concrete pools	146558

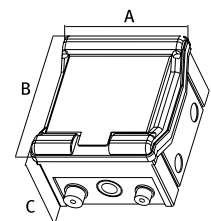

Control panel	Code
Control panel single phase 220V - 2,2 kW	134548
Control panel three phase 400V - 2,2 kW	134549
Control panel three phase 400V - 3 kW	137584



Suction and discharge union	Code
Suction and discharge union of 75mm	11000596